

### Article Info

Received: 25 Jun 2017 | Revised Submission: 20 Jul 2017 | Accepted: 28 Jul 2017 | Available Online: 15 Sept 2017

## Performance Comparison of Cuboidal Box Type Solar Still Deployed with Different Basin Profiles

Abhinav Malaiya\*, Akhilesh Arora\*\* and BB Arora\*\*\*

### ABSTRACT

The need for pure drinking water in dry and remote areas is very acute particularly in Rajasthan, Kuchchh etc. The dry areas however have no shortage of solar energy which is available in plenty. Solar desalination is a technique to curb this problem in dry areas. The work presented in this paper relates to a cuboidal type solar still. The solar still is designed and a sheet of porous material (jute sack) is deployed on different basin profiles placed inside the still and saline water is externally fed. On this vary design, experimentation has been performed to compare the performance of cuboidal box type solar still with different basin profiles and different parameters are measured in this process. The results are obtained at an inclination angle of  $24^\circ$  which is best suited for Rewa Madhya Pradesh (coordinates  $24.53^\circ$  N,  $81.3^\circ$  E ). The process of performance comparison comprises the measurement of productivity and temperatures at different points on solar still.

**Keywords:** Cuboidal Box Type Solar Still; Basin Profiles; Porous Material; Desalination.

### 1.0 Introduction

Pure water is very necessary for the functioning of sustainable environment and for the existence of all living organisms. In this 21<sup>st</sup> century, the quality of water in context of purity is degrading extensively. This degradation of quality of water is due to the discharge of factory waste, effluents, agricultural waste etc. in the sources of fresh water and dumping of medical and chemical waste has also affected the ground water.

In urban areas, this problem has been countered by various highly sophisticated methods but the access to fresh drinking water in arid and remote areas is still a big topic of concern. In these arid remote areas sunlight is in abundance which is channelized for the procurement of distilled water using solar stills. Many researchers have done numerous advancements in this domain. Janardanan [1] established an analytical expression for the thermal efficiency of evaporative heat loss and heat transfer for open and closed cycle system of floating and tilted wick solar still. Dwivedi and Tiwari [2] worked out internal heat transfer coefficient for solar still using different thermal models.

Arjunan [3] reviewed the advancement of solar distillation in India. Hansen [4] exercised an analysis on performance of inclined solar still with different new wick materials and wire mesh. Tiwari and Tiwari [5] analyzed the variation of heat and mass transfer in a passive solar still with water depth in summers.

Alaian [6] investigated the performance of solar still augmented with pin-finned wick by experimental validation.

Ayoub [7] studied solar desalination with enhanced production by the introduction of slow rotating drum in the basin and water sticks to its surface in the form of film and then gets rapidly evaporated. Srivastava [8] presented an experimental validation of effect of absorber material in single slope basin type still. Olalekam [9] used a solar still mounted on a sun tracking mechanism to improve the productivity.

In this research work, an experimental analysis of performance comparison of cuboidal box type solar still with different basin profiles deployed with porous material was exercised in the month of May in Rewa Madhya Pradesh ( $24.53^\circ$ N,  $81.3^\circ$ E) and elevation of 304 m from sea level.

\*Department of Mechanical Engineering, Delhi Technological University, Delhi, India

\*\*Corresponding Author: Department of Mechanical Engineering, Delhi Technological University, Delhi, India  
(E-mail: akhilesharora@dce.ac.in)

\*\*\*Department of Mechanical Engineering, Delhi Technological University, Delhi, India

Two stills one with plane profile and another having profile with cylindrical corrugations along the length of 0.8m are kept in the experimental setup and fed with a common reservoir under the influence of gravity. Saline water was fed from a common reservoir so as to maintain identical feed conditions.

**2.0 Modeling**

The formation of vapors within the still is dependent on the heat transfer coefficient for evaporation. Heat transfer coefficient for evaporation is dependent on the convective heat transfer coefficient between glass cover and wet porous sheet of jute sack. The convective heat transfer coefficient depends upon the difference between the temperature of wet porous sheet and glass cover. It also depends on difference between partial pressures of vapor between wet porous sheet and the glass cover.

To find out the productivity theoretically, relations between convective heat transfer and evaporative heat transfer coefficient specified in [4, 8] can be used.

The convective heat transfer between the wet porous material and glass cover is related as,

$$q_{cwg} = h_{cwg}(T_{wp} - T_g) \tag{1}$$

$$h_{cwg} = 0.884 \{ [T_{wp} - T_g] + [(p_{wp} - p_g)(T_{wp}) / (268900 - p_{wp})] \}^{1/3} \tag{2}$$

Now, evaporative heat transfer coefficient between wet porous surface and glass cover depends upon convective heat transfer coefficient and can be obtained as,

$$h_{ewg} = 0.01623 \times h_{cwg} \times (p_{wp} - p_g) / (T_{wp} - T_g) \tag{3}$$

Now, heat transfer due to evaporation is given as,

$$q_{ewg} = h_{ewg}(T_{wp} - T_g) \tag{4}$$

Hence the quantity of distilled water per hour per square meter of basin area can be calculated from relation,

$$M_d = q_{ewg} / h_{fg} \tag{5}$$

**3.0 Design**

This paper took into cognizance the fact that the still structure to be used should possess a number of features intended to guarantee an efficient and effective evaluation of results.

**3.1 Box type still**

Two cuboids shaped boxes are prepared from the waterproof plywood 9 mm thick. Dimensions of the boxes prepared were 0.8 m × 0.6 m × 0.25m. Edges of boxes were sealed using leak proof sealant (epoxy glue).

Walls of the still are painted with a thick coat of oil paint. Now, whole still is insulated using 15 mm thick Styrofoam (thermal conductivity = 0.33W/mK).

The layer of insulation is painted black for maximum absorptivity. Waterproof sealant is also applied on the outer edges.

As the glass cover and basin are parallel in the still, so it was needed to rest the still on an inclined stand (inclined at 24°).

The purpose of designing a still with parallel glass cover and basin was to reduce the distance between evaporative surface and condensing surface..

As we know, the steam produced at low temperatures has very low enthalpy, this low enthalpy is lost when vapors spent their energy in reaching to the glass cover due to which some amount of vapor condenses prior to reaching the glass cover. In conventional glass slope type solar still these losses are very much dominant.

**3.2 Glass cover**

A transparent glass cover of thickness 3.75mm and transmissivity 0.876 is placed on the top of the basin in order to slopes down its surface into a small trough at its lower edge.

**3.3 Distillate channel**

Distillate channel is the passage on which the cover glass slopes down and condensate gets collected in it.

This distillate channel has a downward slope to make the condensate flow into the beaker. Generally distillate channel is made up of aluminium sheet but aluminium sheet posses a property of getting heated up due to which the condensate evaporates from channel and productivity decreases.

To overcome this drawback 10<sup>th</sup> grade winding plastic is used to make the distillate channel.

This plastic channel is also smooth which allows all of the condensate to flow down into the beaker.

**Fig 1: Box Type Still**



**Fig 2: Still with Glass Cover**



### 3.4 Profiles

In two stills, different profile set-up was inserted for the purpose of comparison. Sheet of jute sack which was used in following profiles was blackened using No. 10 black die (generally used for clothes) so as to increase the amount of radiation to be absorbed by the material. The property that made me use jute sack to prepare still basin was its thermal inertia.

Thermal inertia of Jute is very less as compared to water. Thermal inertia is the property of material by virtue of which it resists any change in temperature. Thermal inertia also indicates the ability of material to store heat.

The lower the value of thermal inertia there will be a higher and rapid rise in temperature as a result of which more amount of steam will get evaporated from surface and productivity of still will increase.

**Fig 3: Blackened Porous Sheet of Jute**



#### 3.4.1 Plane profile

Plane profile was simply a porous sheet of jute sack rested on plane G.I. sheet (thermal conductivity 18W/m K). The G.I. sheet beneath the sheet of jute sack was blackened with oil paint mixed with some ash to increase the absorptivity.

#### 3.4.2 Improved profile

Improved profile was prepared by shaping a plan G.I. sheet over number of 75mm diameter pipes. The cylindrical troughs produced on the profile are 0.75m<sup>2</sup> in length and each trough having diameter of nearly 75mm. The purpose of creating new profile was to increase the evaporative surface area.

### 3.5 Feed system

Feed system for this experiment was prepared using a bucket with two cocks (cocks used in water purifiers). These cocks were then connected to a pipe inside the solar still which have multiple holes along its length for proper distribution of water over jute sheet. Flow of water was controlled by regulating the cock opening.

**Fig 4: Improved Profile**



**Fig 4: Gravity Feed System**

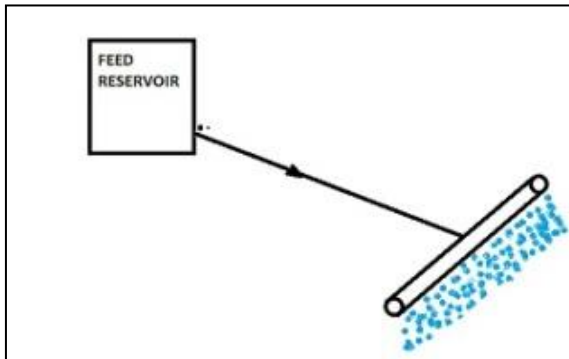

Here feed system works under gravity due to difference in potential heads. A reservoir was kept at higher elevation than still supplies feed water to the still. For equal distribution of feed water over porous jute sheet, pipes from the cocks of the reservoir are connected to a pipe in solar still. This pipe in solar still have number of holes along its length for uniform distribution of feed water. For constant flow rate, we need to maintain constant head in the reservoir.

**4.0 Experimental Set-Up**

The experimentation was done in the month of May in year 2016. Readings of different parameters like glass cover temperature, basin temperature and productivity ( $\text{ml}/\text{m}^2$ ) were recorded hourly from 6a.m. to 6p.m. for 10 days from 1<sup>st</sup> May to 10<sup>th</sup> May.

**Fig 5: Set-Up for Solar Still**

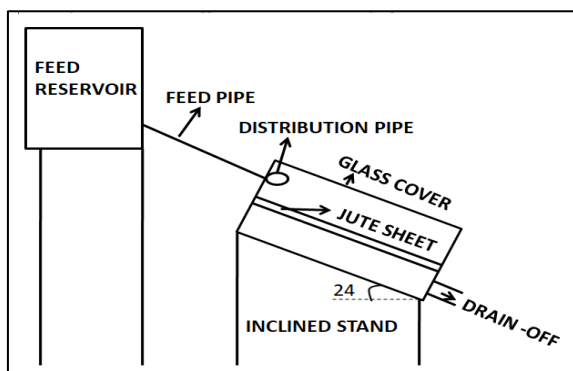

In experimental setup, two solar stills of same size i.e.  $0.8\text{m} \times 0.6\text{m} \times 0.25\text{m}$  were rested on stands. These stands have  $24^\circ$  angle of inclination with the horizontal. Then both the stills were connected to a

common feed reservoir to maintain same feed conditions for both the stills (same flow rate, same elevation etc.)

A drain off pipe was installed at the lower corner of stills for draining excess water from stills. This excess drain of water can be collected in another vessel or can be re-circulated to feed reservoir using a pump. In this case, drain off was collected in a vessel. Then stills were oriented with respect to the position of the sun at 6 a.m. using a hand held compass, such that maximum radiation fall on the stills. Beakers were placed underneath the outlet of the distillate channel for measuring the output or productivity.

**Fig 6: Experimental Set-Up**

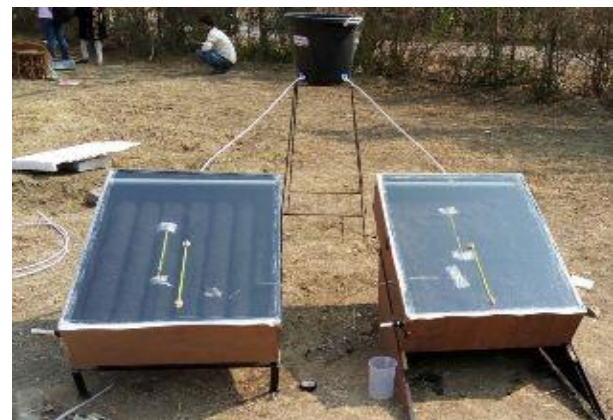

**4.1 Instruments used**

**4.1.1 J-Type thermocouple**

A J-type thermocouple, with iron constantan bead was used to measure glass cover temperature and basin temperature. The operating range for the thermocouple was from  $-20^\circ\text{C}$  to  $200^\circ\text{C}$  with the accuracy of  $\pm 1.1^\circ\text{C}$ . alcohol type thermometers were also used with it.

**Fig 7: J-Type Thermocouple**





Fig 8: Solar Power Meter



Fig 9: Variation of Glass Cover Temperature with Time

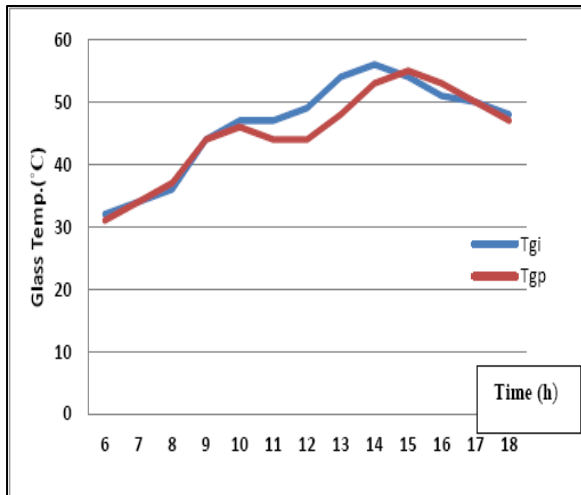

Fig 10: Variation of Basin Temperature with Time

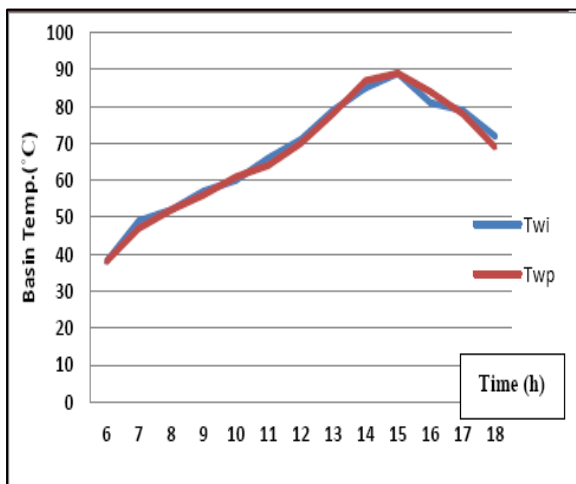

Fig 11: Variation of Productivity with Time

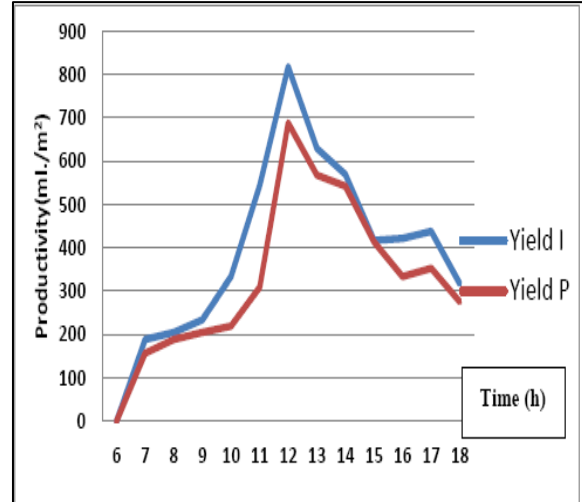
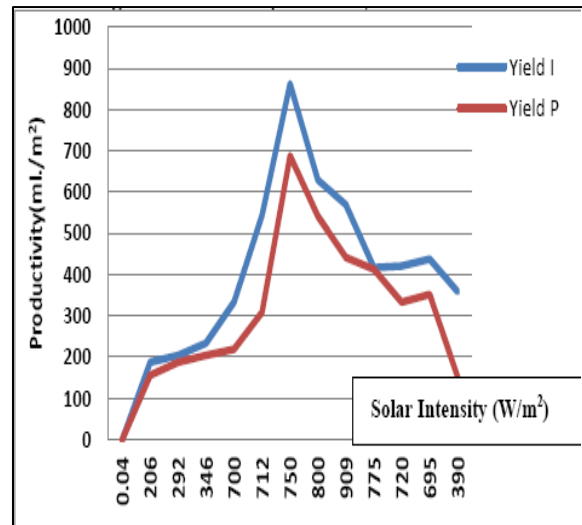

Fig 12: Variation of Productivity with Solar Intensity



T<sub>gi</sub>= Temperature of glass cover for improved profile still

T<sub>gp</sub>= Temperature of glass cover for plane profile still

T<sub>wi</sub>= Temperature of basin for still with improved profile

T<sub>wp</sub>= Temperature of basin for still with plane profile

Yield<sub>i</sub>= Productivity of still with improved profile

Yield<sub>p</sub>= Productivity of still with plane profile

#### 4.1.2 Solar power meter

A hand held solar power meter TM-206 was used to record the solar radiation data. Specifications are:-

- 3.5 digital LCD display with maximum reading of 2000 W/m<sup>2</sup>.
- Display units W/m<sup>2</sup> and Btu.
- Data hold/max/min/function
- Ambient temperature measurement

#### 5.0 Results and Discussions

For same projected basin area the still with improved profile yields more fresh water as the evaporative surface area increases. So, by using many more different profiles with areas more than plane profile will result in good productivity as well. Other suggested profiles could be pin finned profile, profile with spherical corrugations etc. Use of charcoal on the absorber surface is also an option that can give results which are significantly better.

#### 6.0 Conclusions

From above experimental results following conclusion are drawn:-

- The day around productivity of still with improved profile was 24.6% more as compared to still with plane profile under identical conditions.
- The improved profile with cylindrical corrugations results in more productivity than plane profile because of increased evaporative surface area with corrugations.

So above experiment conclude that by using different basin profiles with increased surface area productivity can be increased to a great extent.

#### References

- [1] Janardanan. Evaporative heat loss and heat transfer for open and closed system of a floating tilted wick solar still. *Desalination* 180 ,2005, 291-305.
- [2] VK Dwivedi, Tiwari. Comparison of internal heat transfer coefficients in passive solar still by different thermal models: An experiment validation. *Desalination* 246, 2009, 304-318.
- [3] Arjunan. Status of solar desalination in India. *Renewable and sustainable energy reviews* 13, 2009, 2408-2418.
- [4] RSI Hansen. Performance analysis of inclined solar still with different new wick materials and wire mesh. *Desalination* 358, 2015, 1-8.
- [5] Tiwari, Tiwari. Effect of water depth on heat and mass transfer in a passive solar still:in summer climate conditions. *Desalination* 195, 2006, 78-94
- [6] WM Alain. Experiment investigaton on the performance of solar still arrangement with pin finned wick. *Desalination* 329, 2016, 10-15.
- [7] GM Ayoub. A solar desalination system with enhanced productivity.
- [8] PK Srivastava. Effect of absorber material on the performance of basin type solar still with multiple floating porous absorber, 2013
- [9] Taiwo, Olalekam. Improving the performance of solar stills using sun tracking, 2010, Thesis, University of Strathclyde Engineering.
- [10] OO Badran. Experimental study of the enhancement parameters on a single slope solar still productivity. *Desalination* 209, 2007, 136-143.
- [11] A Safwat Nafey. Enhancement of solar still productivity using floating perforated black plate. April 2001. *Energy conversion and management* 43, 2002, 937-946.
- [12] SA El-Agouz. Performance evaluation of a continuous flow inclined solar still desalination system. *Energy conversion and management* 101, 2015, 606-615.

- [13] A Alaudeen. Study on stepped type basin in a solar still, 2013.

**Nomenclature**

$h_{cwg}$	convective heat transfer coefficient	(W/m <sup>2</sup> °C)
$q_{cwg}$	convective heat transfer rate	(W/m <sup>2</sup> )
$h_{ewg}$	evaporative heat transfer coefficient	(W/m <sup>2</sup> °C)
$q_{ewg}$	evaporative heat transfer rate	(W/m <sup>2</sup> )
$T_{wp}$	temperature of basin	(°C)
$T_g$	temperature of glass cover	(°C)
$m_d$	quantity of water obtained	(kg/h)
$h_{fg}$	latent heat at basin temperature	(kJ/kg)
$p_{wp}$	saturation pressure at basin temperature	(mm of Hg)
$p_g$	saturation pressure at glass temperature	(mm of Hg)

**Subscripts**

- wp basin  
g glass cover